

PNP Silicon AF Transistor

- For AF input stages and driver applications
- High current gain
- Low collector-emitter saturation voltage
- Low noise between 30 Hz and 15 kHz
- Complementary types: BC847BF, BC848BF
BC849BF, BC850BF (NPN)

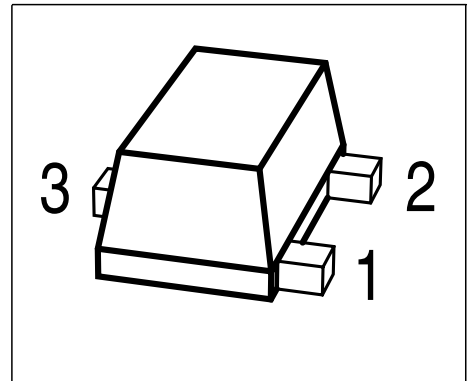

Type	Marking	Pin Configuration			Package
BC857BF	3Fs	1 = B	2 = E	3 = C	TSFP-3
BC858BF	3Ks	1 = B	2 = E	3 = C	TSFP-3
BC859BF	4Bs	1 = B	2 = E	3 = C	TSFP-3
BC860BF	4Fs	1 = B	2 = E	3 = C	TSFP-3

Maximum Ratings

Parameter	Symbol	Value	Unit
Collector-emitter voltage	V_{CEO}		V
BC857BF, BC860BF		45	
BC858BF, BC859BF		30	
Collector-emitter voltage	V_{CES}		
BC857BF, BC860BF		50	
BC858BF, BC859BF		30	
Collector-base voltage	V_{CBO}		
BC857BF, BC860BF		50	
BC858BF, BC859BF		30	
Emitter-base voltage	V_{EBO}		
BC857BF, BC860BF		5	
BC858BF, BC859BF		5	
Collector current	I_C	100	mA
Peak collector current	I_{CM}	200	
Peak base current	I_{BM}	200	
Peak emitter current	I_{EM}	200	mA
Total power dissipation, $T_S \leq 128^\circ\text{C}$	P_{tot}	250	mW
Junction temperature	T_j	150	$^\circ\text{C}$
Storage temperature	T_{stg}	-65 ... 150	

Thermal Resistance

Parameter	Symbol	Value	Unit
Junction - soldering point ¹⁾	R_{thJS}	≤ 90	K/W

Electrical Characteristics at $T_A = 25^\circ\text{C}$, unless otherwise specified

Parameter	Symbol	Values			Unit
		min.	typ.	max.	

DC Characteristics

Collector-emitter breakdown voltage $I_C = 10\text{ mA}$, $I_B = 0\text{ mA}$, BC857BF, BC860BF $I_C = 10\text{ mA}$, $I_B = 0\text{ mA}$, BC858BF, BC859BF	$V_{(BR)CEO}$	45 30	- -	- -	V
Collector-base breakdown voltage $I_C = 10\text{ }\mu\text{A}$, $I_E = 0\text{ mA}$, BC857BF, BC860BF $I_C = 10\text{ }\mu\text{A}$, $I_E = 0\text{ mA}$, BC858BF, BC859BF	$V_{(BR)CBO}$	50 30	- -	- -	
Collector-emitter breakdown voltage $I_C = 10\text{ }\mu\text{A}$, $V_{BE} = 0\text{ V}$, BC857BF, BC860BF $I_C = 10\text{ }\mu\text{A}$, $V_{BE} = 0\text{ V}$, BC858BF, BC859BF	$V_{(BR)CES}$	50 30	- -	- -	
Emitter-base breakdown voltage $I_E = 1\text{ }\mu\text{A}$, $I_C = 0\text{ }\mu\text{A}$	$V_{(BR)EBO}$	5	-	-	
Collector-base cutoff current $V_{CB} = 30\text{ V}$, $I_E = 0\text{ A}$ $V_{CB} = 30\text{ V}$, $I_E = 0\text{ A}$, $T_A = 150\text{ }^\circ\text{C}$	I_{CBO}	- -	- -	0.015 5	μA
DC current gain ²⁾ $I_C = 10\text{ }\mu\text{A}$, $V_{CE} = 5\text{ V}$ $I_C = 2\text{ mA}$, $V_{CE} = 5\text{ V}$	h_{FE}	- 220	250 290	- 475	-
Collector-emitter saturation voltage ²⁾ $I_C = 10\text{ mA}$, $I_B = 0.5\text{ mA}$ $I_C = 100\text{ mA}$, $I_B = 5\text{ mA}$	V_{CEsat}	- -	75 250	300 650	mV
Base emitter saturation voltage ²⁾ $I_C = 10\text{ mA}$, $I_B = 0.5\text{ mA}$ $I_C = 100\text{ mA}$, $I_B = 5\text{ mA}$	V_{BEsat}	- -	700 850	- -	
Base-emitter voltage ²⁾ $I_C = 2\text{ mA}$, $V_{CE} = 5\text{ V}$ $I_C = 10\text{ mA}$, $V_{CE} = 5\text{ V}$	$V_{BE(ON)}$	600 -	650 -	750 820	

¹For calculation of R_{thJA} please refer to Application Note Thermal Resistance

²Pulse test: $t < 300\mu\text{s}$; $D < 2\%$

AC Characteristics

Transition frequency $I_C = 20 \text{ mA}$, $V_{CE} = 5 \text{ V}$, $f = 100 \text{ MHz}$	f_T	-	250	-	MHz
Collector-base capacitance $V_{CB} = 10 \text{ V}$, $f = 1 \text{ MHz}$	C_{cb}	-	3	-	pF
Emitter-base capacitance $V_{EB} = 0.5 \text{ V}$, $f = 1 \text{ MHz}$	C_{eb}	-	10	-	
Short-circuit input impedance $I_C = 2 \text{ mA}$, $V_{CE} = 5 \text{ V}$, $f = 1 \text{ kHz}$	h_{11e}	-	4.5	-	k Ω
Open-circuit reverse voltage transf. ratio $I_C = 2 \text{ mA}$, $V_{CE} = 5 \text{ V}$, $f = 1 \text{ kHz}$	h_{12e}	-	2	-	10^{-4}
Short-circuit forward current transf. ratio $I_C = 2 \text{ mA}$, $V_{CE} = 5 \text{ V}$, $f = 1 \text{ kHz}$	h_{21e}	-	330	-	-
Open-circuit output admittance $I_C = 2 \text{ mA}$, $V_{CE} = 5 \text{ V}$, $f = 1 \text{ kHz}$	h_{22e}	-	30	-	μS
Noise figure $I_C = 200 \mu\text{A}$, $V_{CE} = 5 \text{ V}$, $f = 1 \text{ kHz}$, $\Delta f = 200 \text{ Hz}$, $R_S = 2 \text{ k}\Omega$, BC859BF $I_C = 200 \mu\text{A}$, $V_{CE} = 5 \text{ V}$, $f = 1 \text{ kHz}$, $\Delta f = 200 \text{ Hz}$, $R_S = 2 \text{ k}\Omega$, BC860BF	F	-	1	4	dB
		-	1	4	
Equivalent noise voltage $I_C = 200 \mu\text{A}$, $V_{CE} = 5 \text{ V}$, $R_S = 2 \text{ k}\Omega$, $f = 10...50 \text{ Hz}$, BF860BF	V_n	-	-	0.11	μV

DC current gain $h_{FE} = f(I_C)$

$V_{CE} = 5\text{ V}$

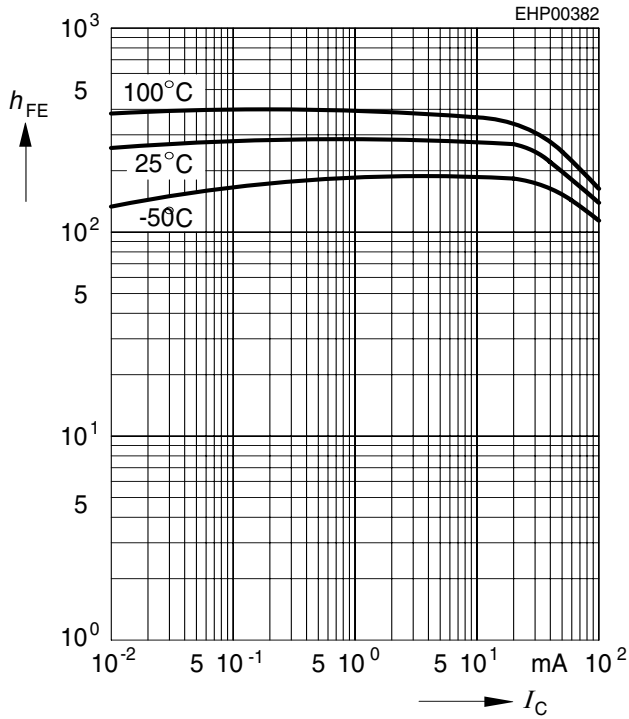

Collector-emitter saturation voltage

$I_C = f(V_{CEsat}), h_{FE} = 20$

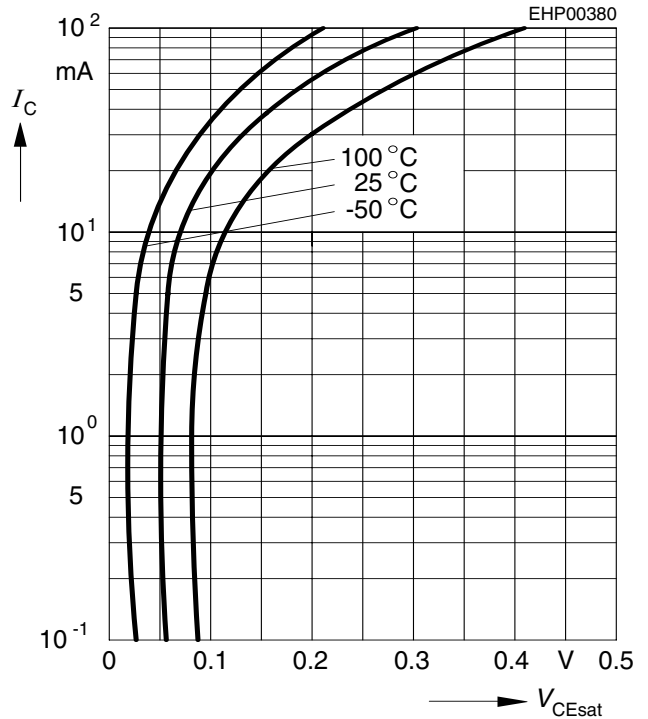

Base-emitter saturation voltage

$I_C = f(V_{BEsat}), h_{FE} = 20$

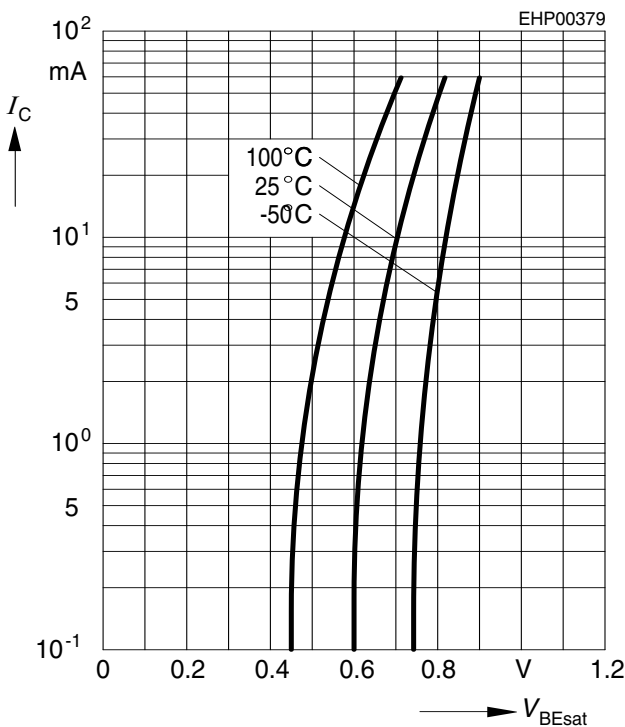

Collector cutoff current $I_{CBO} = f(T_A)$

$V_{CB} = 30\text{ V}$

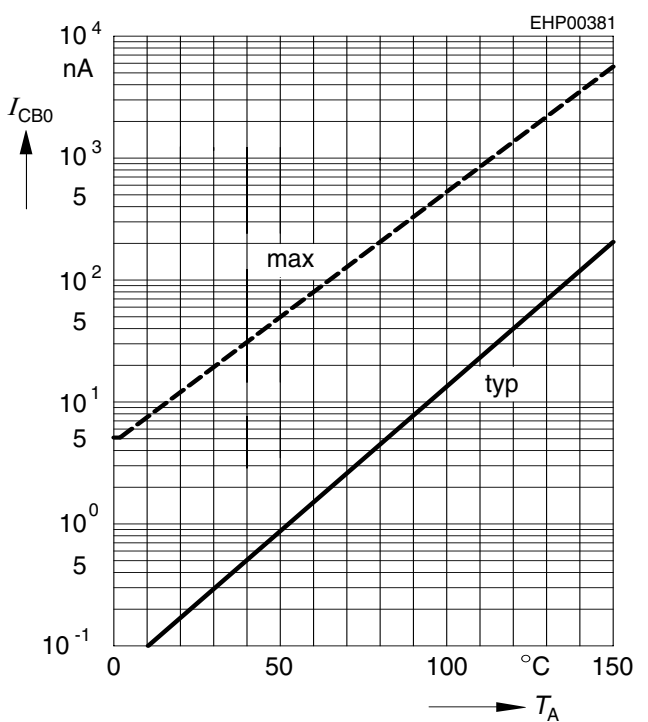

Transition frequency $f_T = f(I_C)$

$V_{CE} = 5\text{ V}$

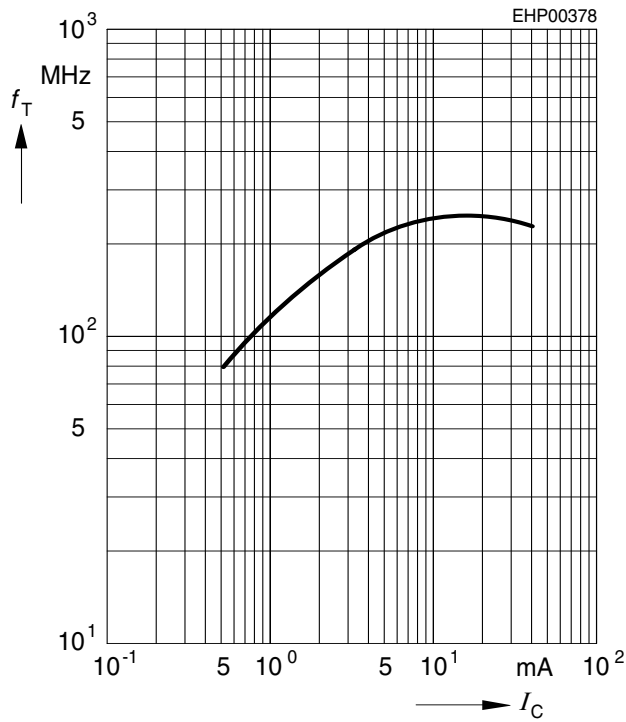

Collector-base capacitance $C_{CB} = f(V_{CB0})$

Emitter-base capacitance $C_{EB} = f(V_{EB0})$

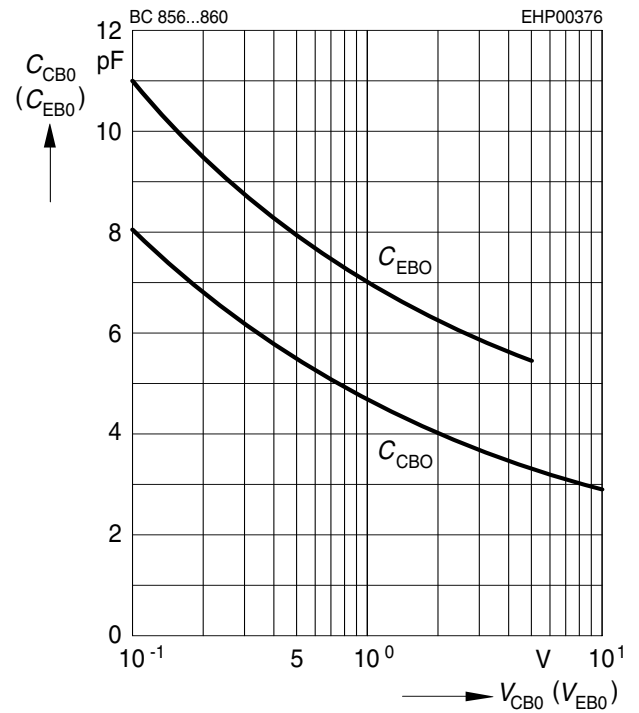

Total power dissipation $P_{tot} = f(T_S)$

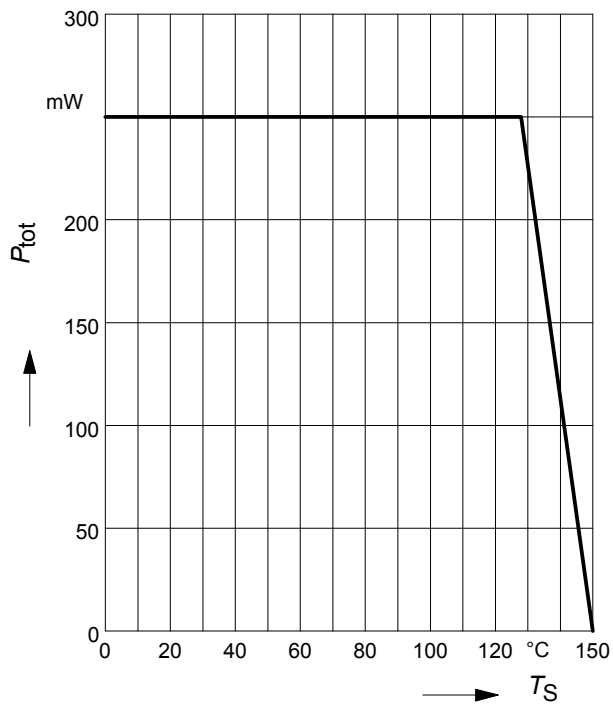

Permissible Pulse Load $R_{thJS} = f(t_p)$

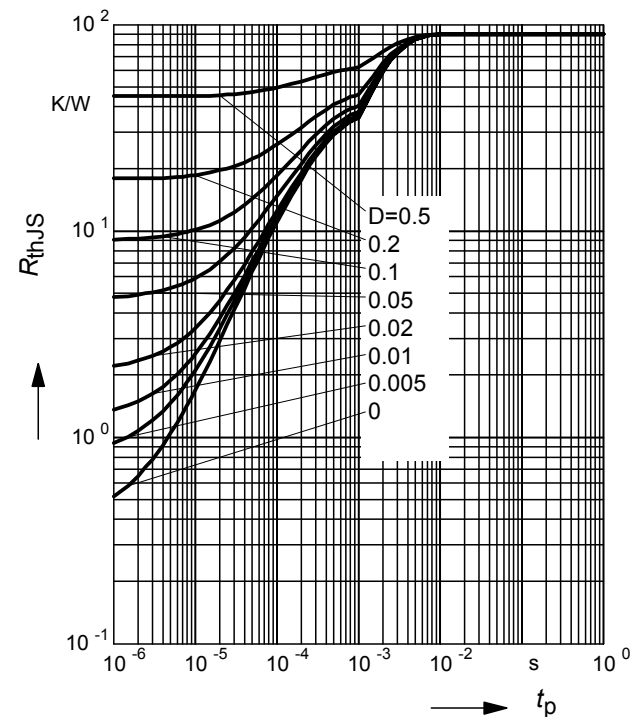

Permissible Pulse Load

$$P_{totmax}/P_{totDC} = f(t_p)$$

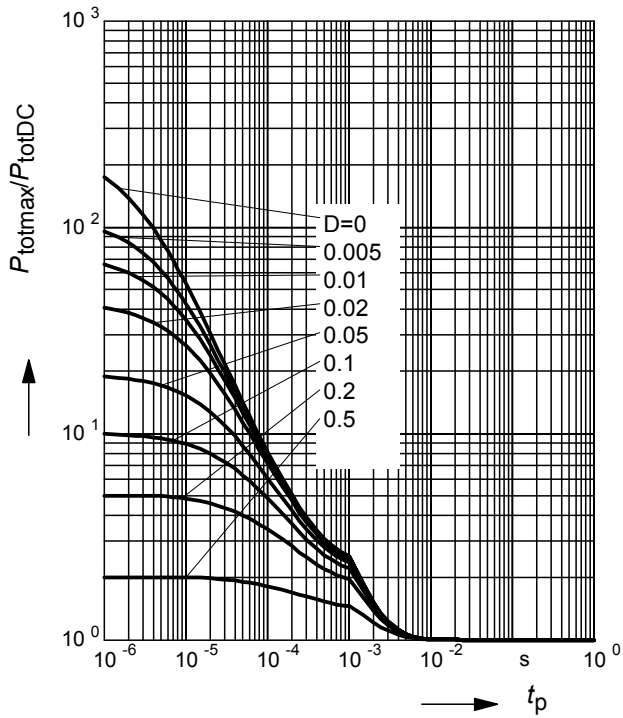

h parameter $h_e = f(I_C)$ normalized

$$V_{CE} = 5V$$

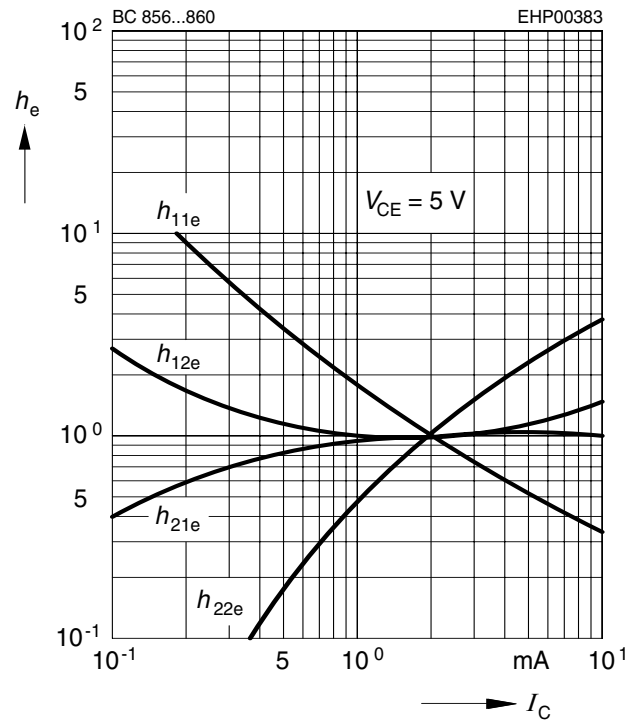

h parameter $h_e = f(V_{CE})$ normalized

$$I_C = 2mA$$

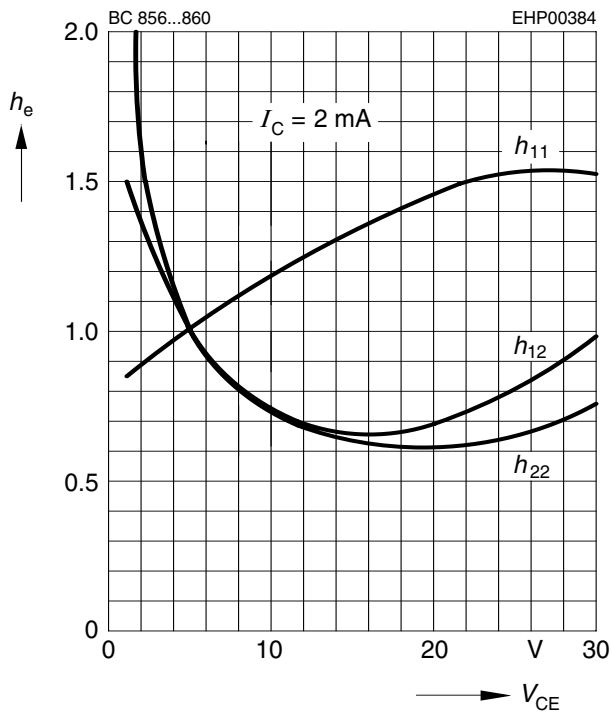

Noise figure $F = f(V_{CE})$

$$I_C = 0.2mA, R_S = 2k\Omega, f = 1kHz$$

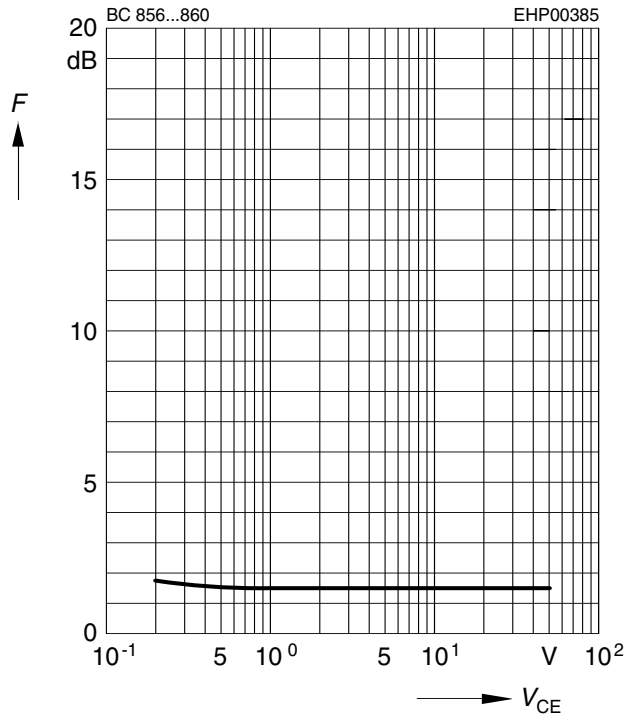

Noise figure $F = f(f)$

$I_C = 0.2\text{mA}$, $V_{CE} = 5\text{V}$, $R_S = 2\text{k}\Omega$

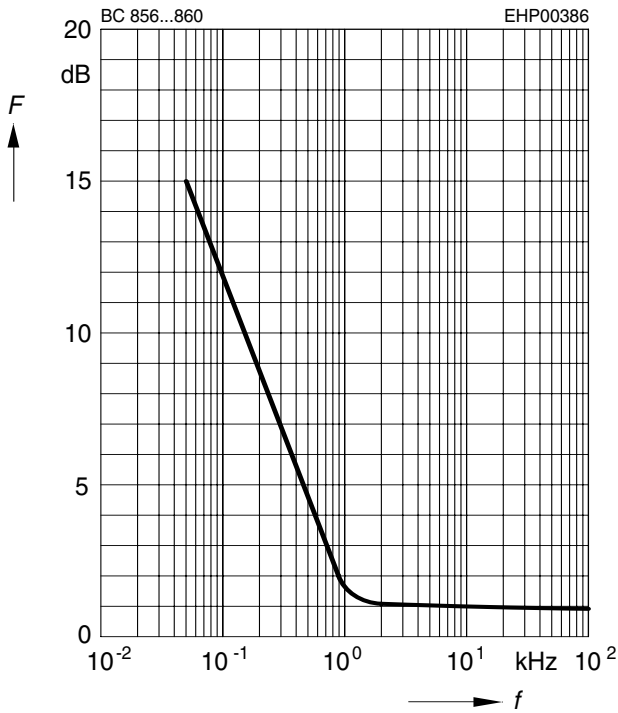

Noise figure $F = f(I_C)$

$V_{CE} = 5\text{V}$, $f = 120\text{Hz}$

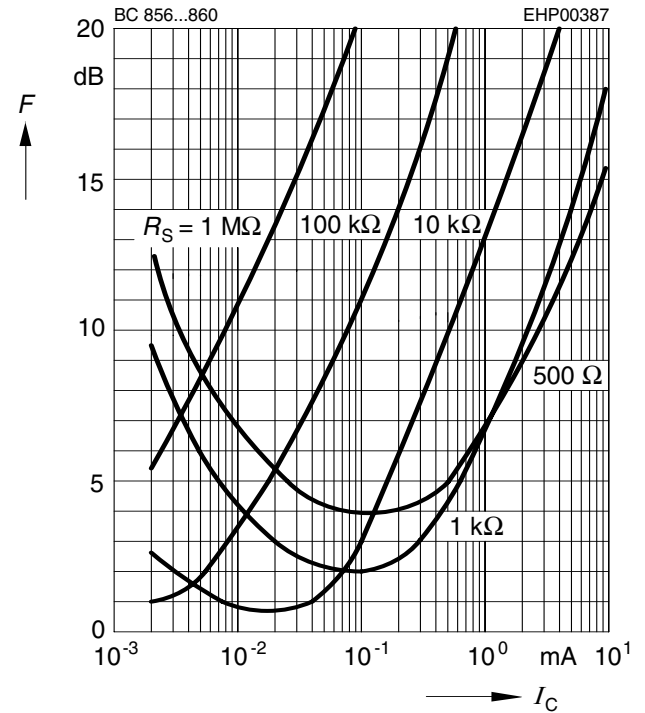

Noise figure $F = f(I_C)$

$V_{CE} = 5\text{V}$, $f = 1\text{kHz}$

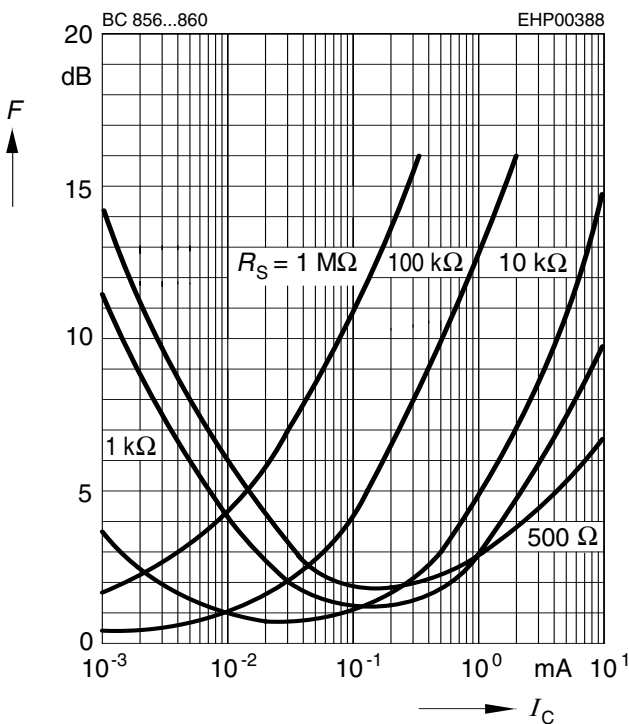

Noise figure $F = f(I_C)$

$V_{CE} = 5\text{V}$, $f = 10\text{kHz}$

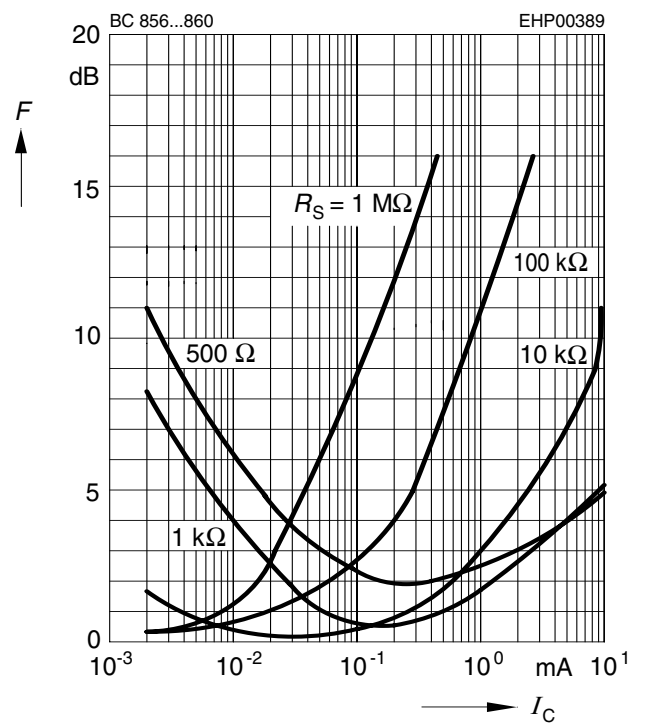

**Published by Infineon Technologies AG,
St.-Martin-Strasse 53,
81669 München**

**© Infineon Technologies AG 2004.
All Rights Reserved.**

Attention please!

The information herein is given to describe certain components and shall not be considered as a guarantee of characteristics.

Terms of delivery and rights to technical change reserved.

We hereby disclaim any and all warranties, including but not limited to warranties of non-infringement, regarding circuits, descriptions and charts stated herein.

Information

For further information on technology, delivery terms and conditions and prices please contact your nearest Infineon Technologies Office (www.infineon.com).

Warnings

Due to technical requirements components may contain dangerous substances. For information on the types in question please contact your nearest Infineon Technologies Office.

Infineon Technologies Components may only be used in life-support devices or systems with the express written approval of Infineon Technologies, if a failure of such components can reasonably be expected to cause the failure of that life-support device or system, or to affect the safety or effectiveness of that device or system. Life support devices or systems are intended to be implanted in the human body, or to support and/or maintain and sustain and/or protect human life. If they fail, it is reasonable to assume that the health of the user or other persons may be endangered.